

# COLLAR

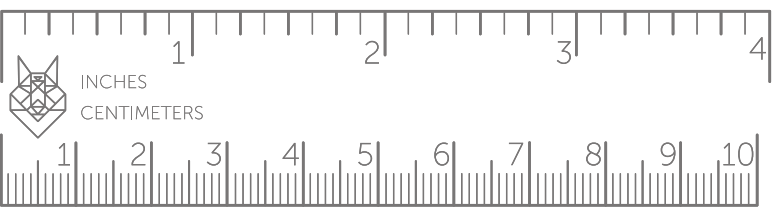

- CUT **4** CONTRAST
  - CUT **2** FUSIBLE INTERFACING
- 1/2" (1.3 cm) seams allowed

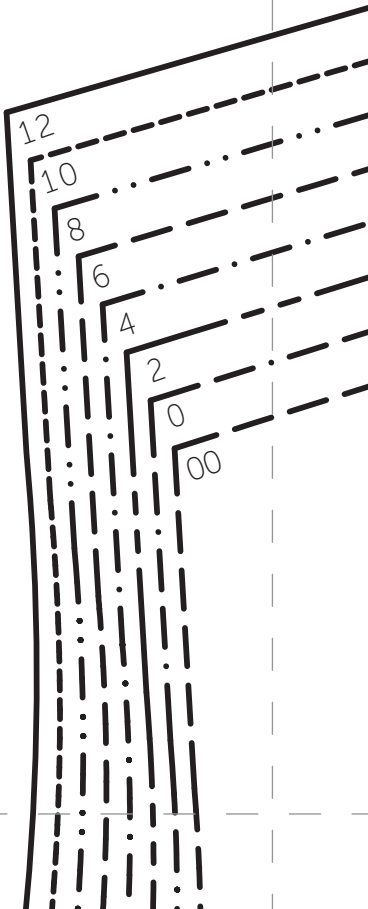

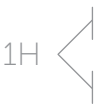

1I

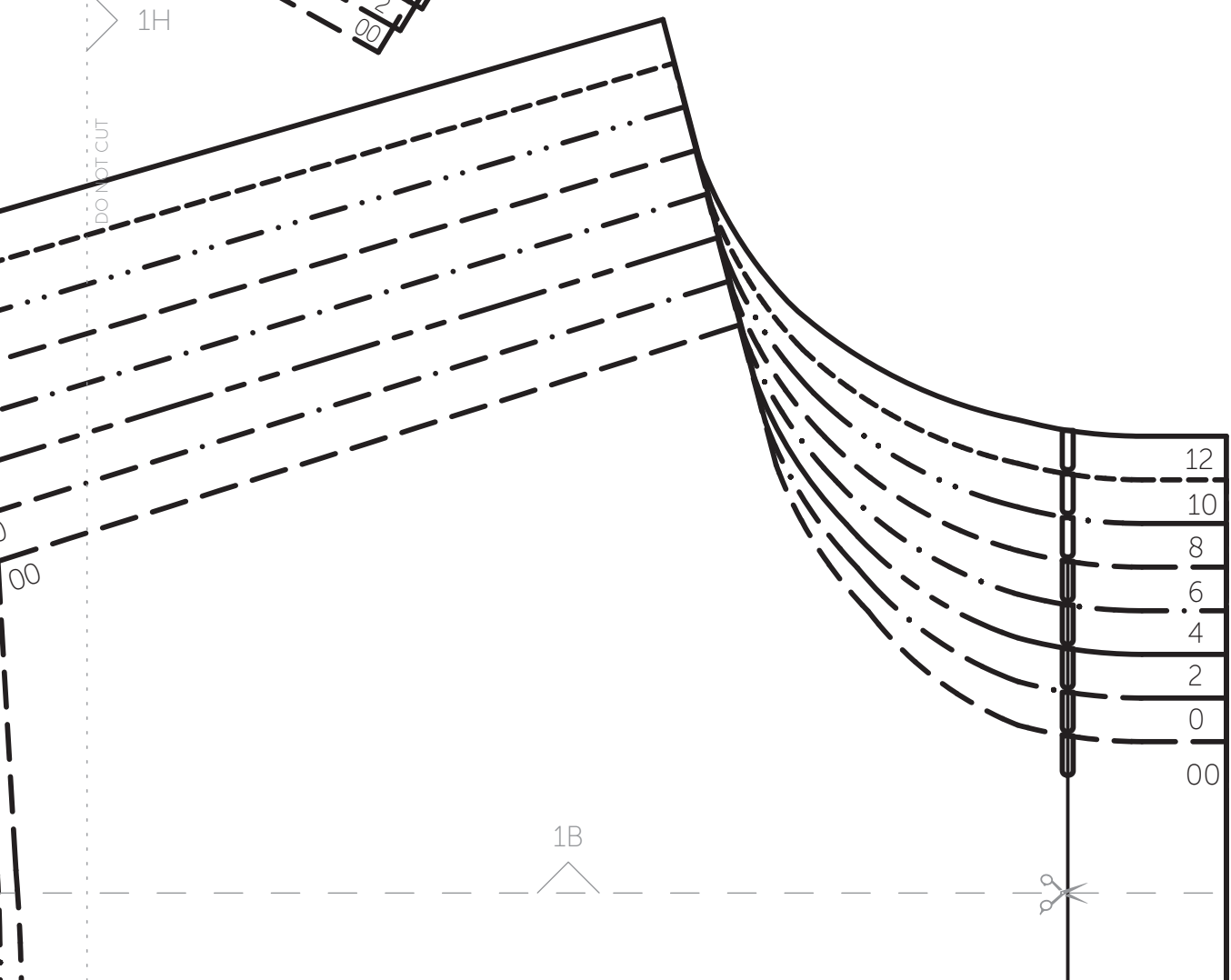
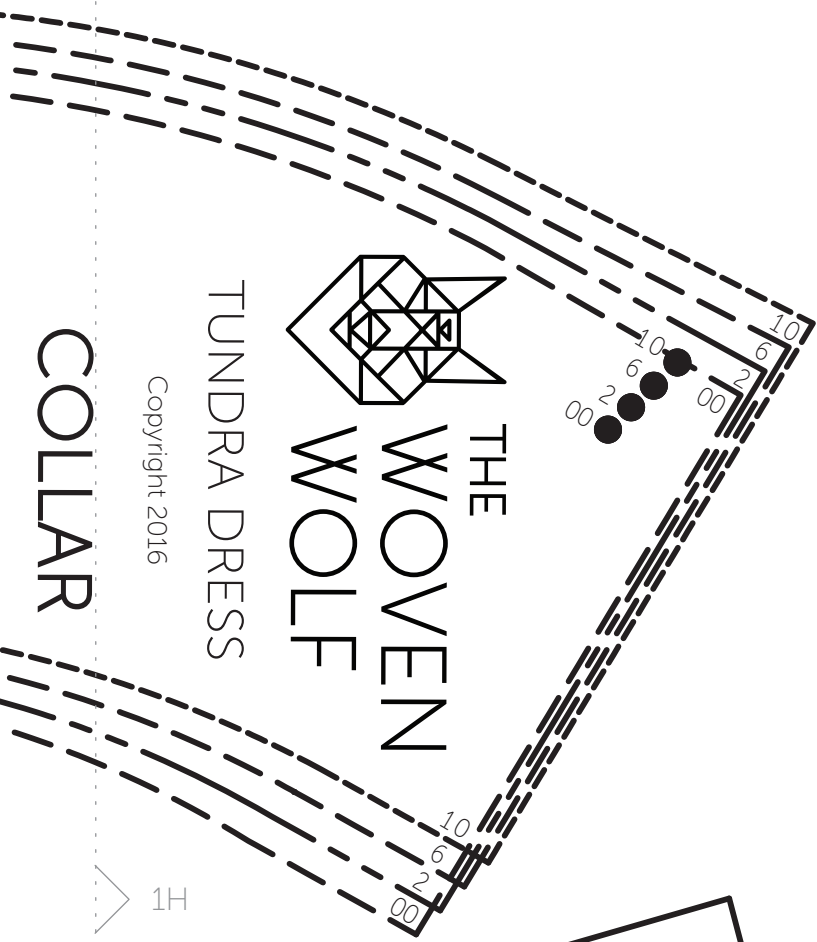



DO NOT CUT

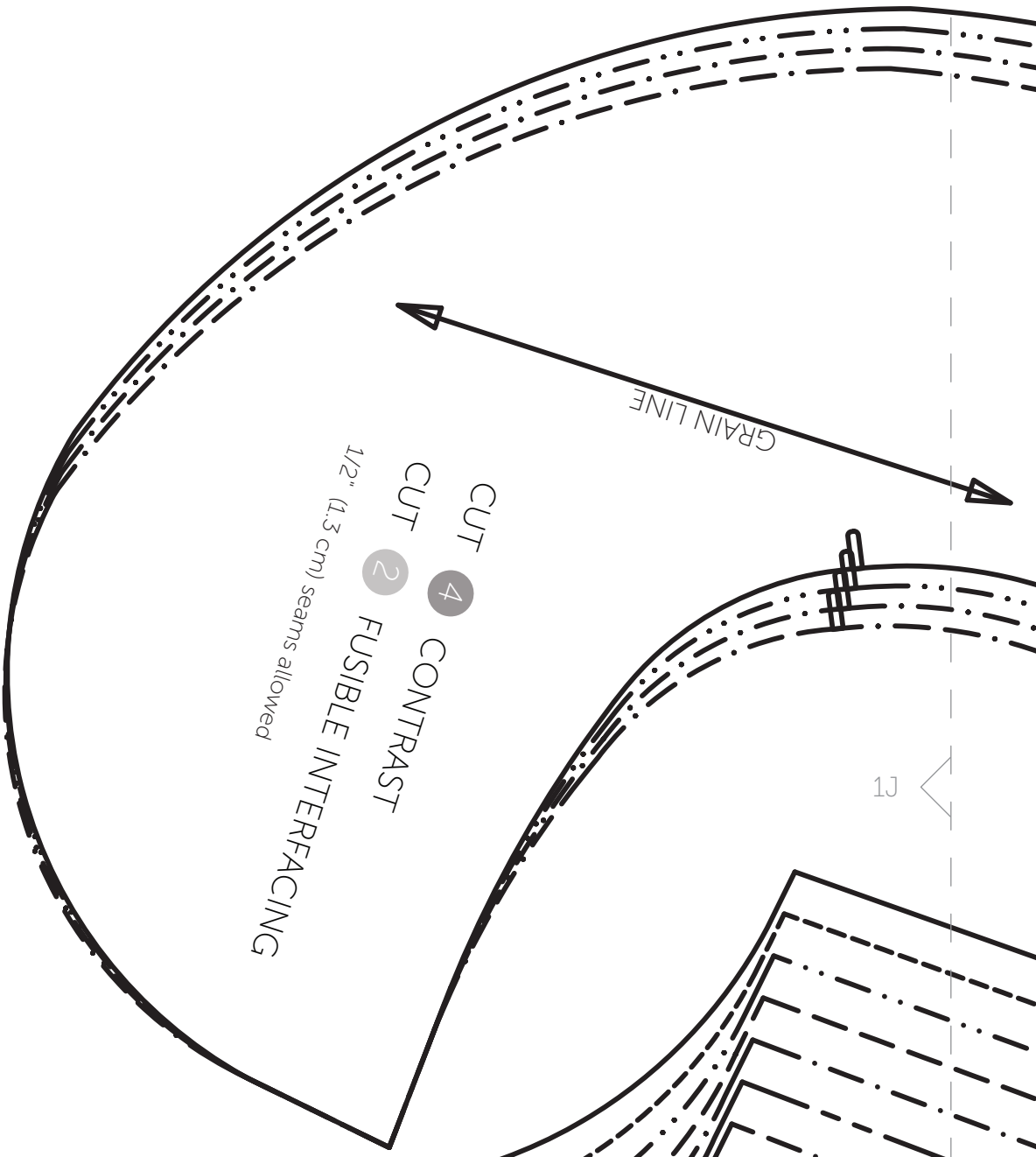

1J

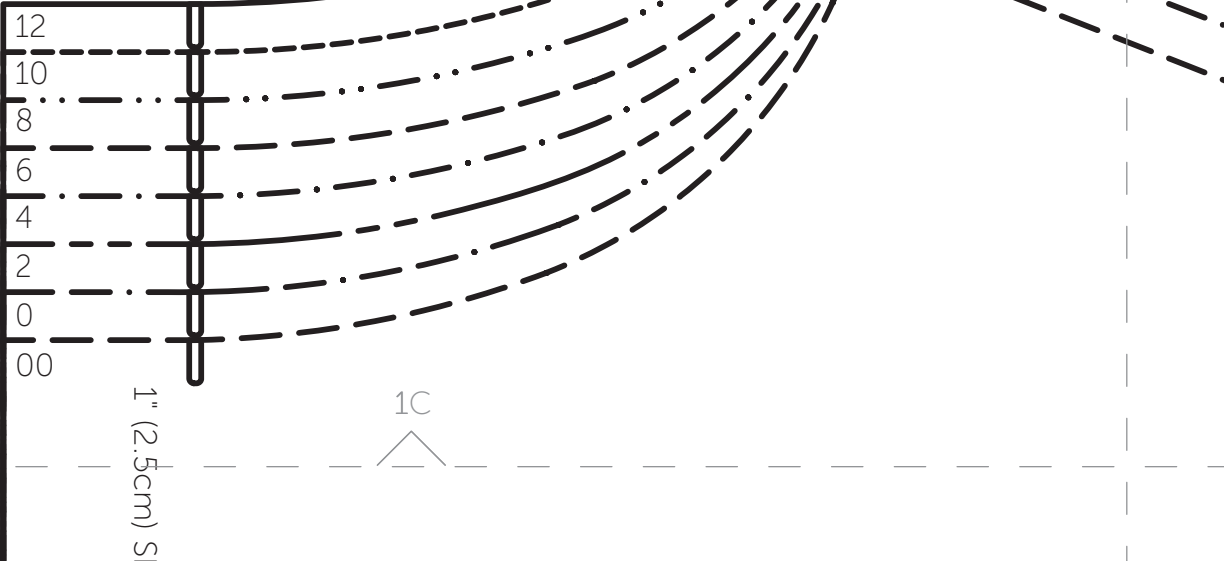

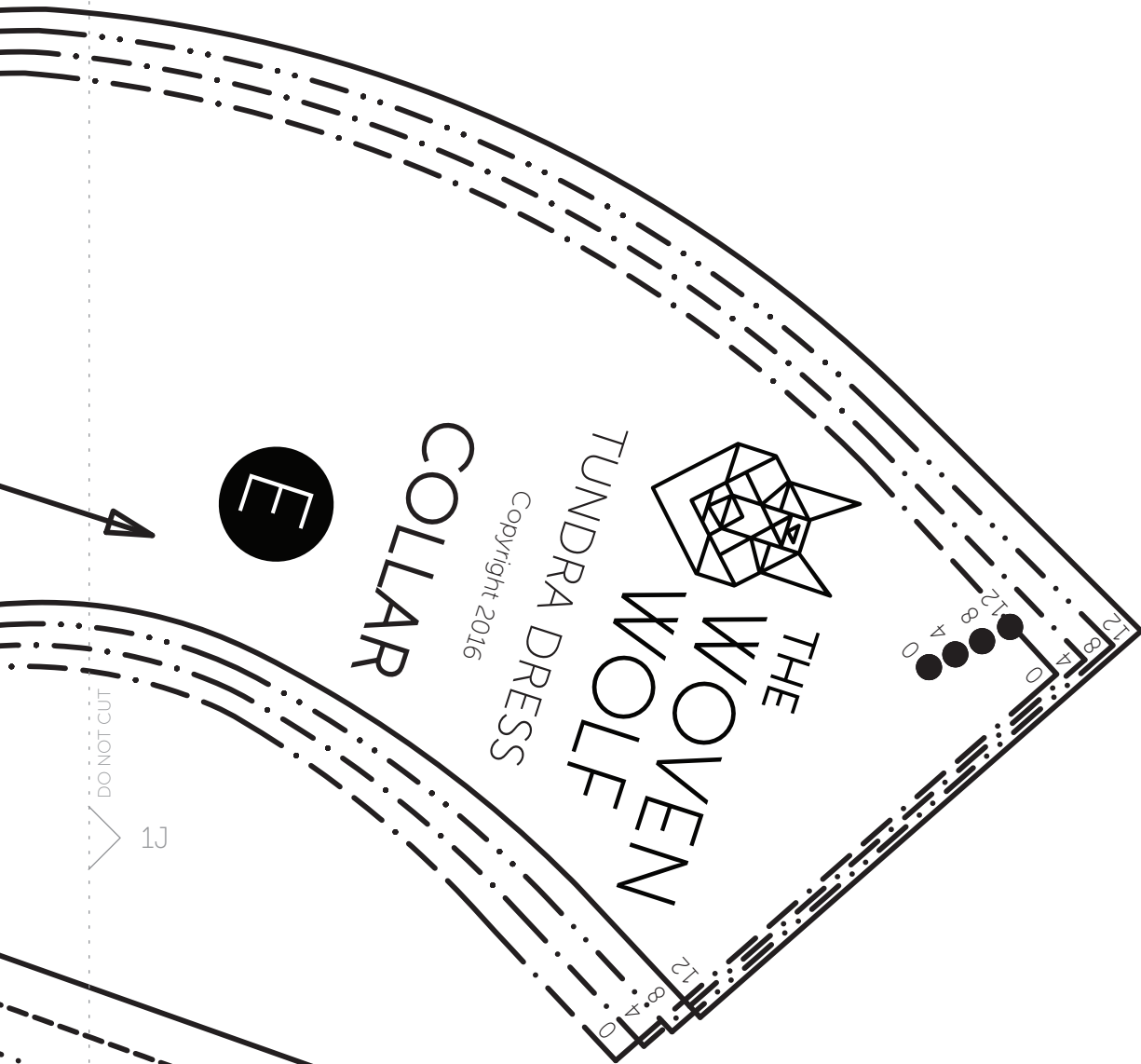

1K

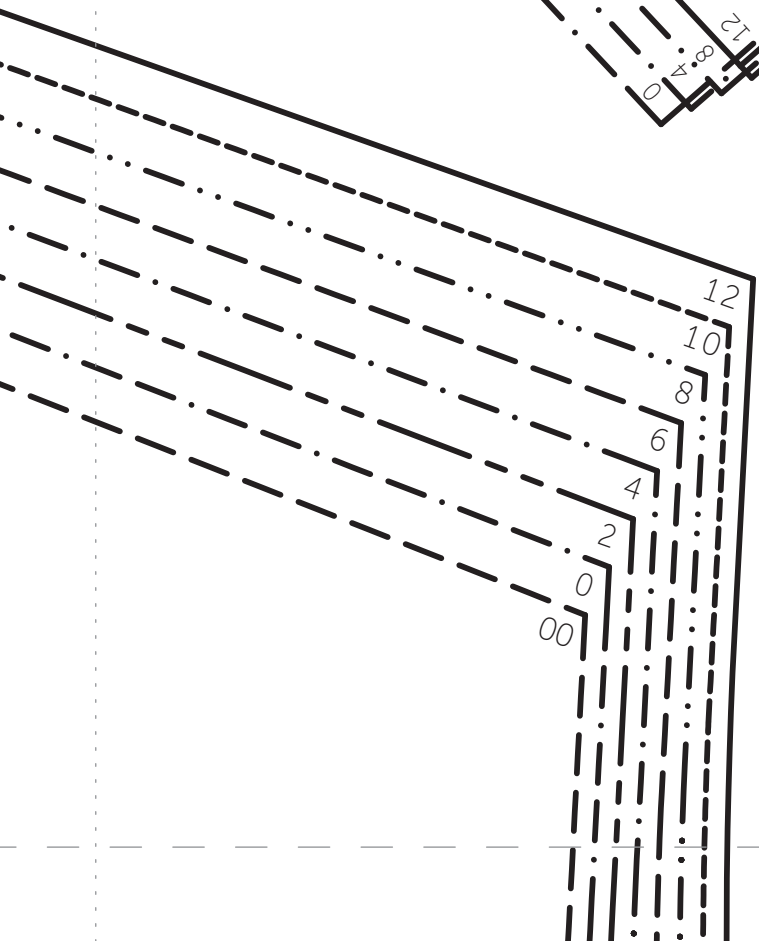

DO NOT CUT

1J

1D



DO NOT CUT

1A

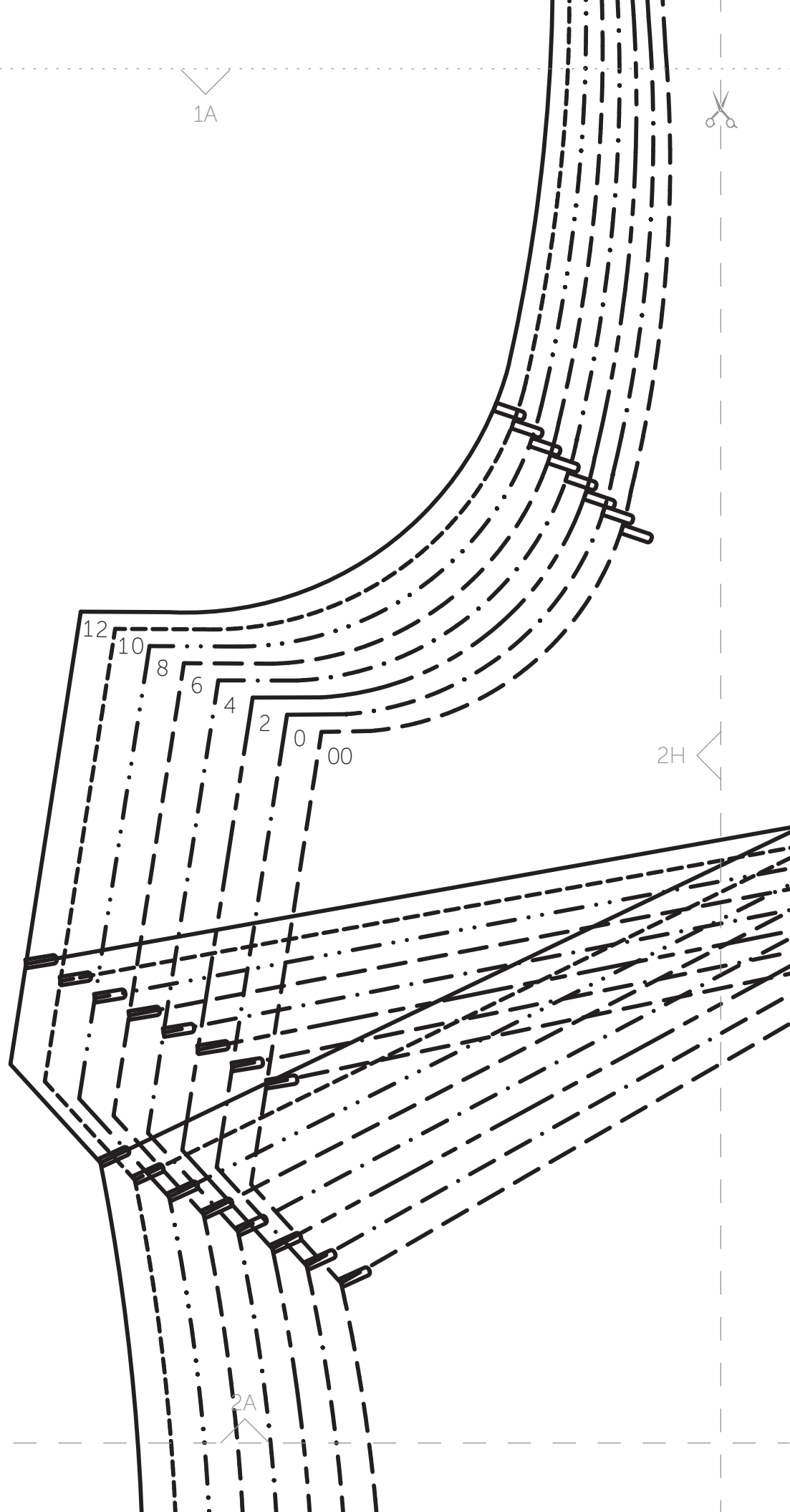

2H

2A



DO NOT CUT

1B

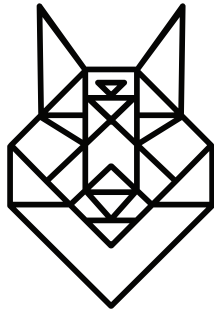

# THE WOVEN WOLF

## TUNDRA DRESS

Copyright 2016

# FRONT

CUT **1** ON FOLD - SELF FABRIC

1/2" (1.3 cm) seams allowed

Placket placement - mark on right hand side only



2I



2H

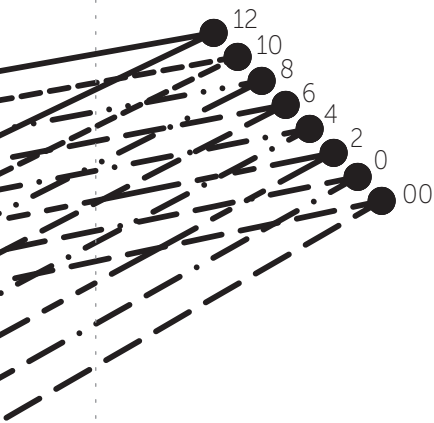

DO NOT CUT

2B



DO NOT CUT

DO NOT CUT

1" (2.5cm) SEAM ALLOWED AT CENTER BACK

1C

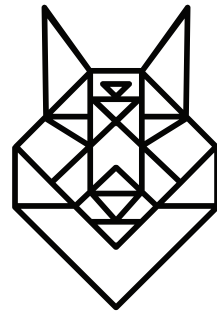

THE  
WOVEN  
WOLF

TUNDRA DRESS

Copyright 2016 2J

BACK

CUT 2 SELF FABRIC

1/2" (1.3 cm) seams allowed unless otherwise indicated



2C



2I

VEN  
LF  
ESS

2J

BRIC  
otherwise indicated

DO NOT CUT

1D

DO NOT CUT



2K

2D

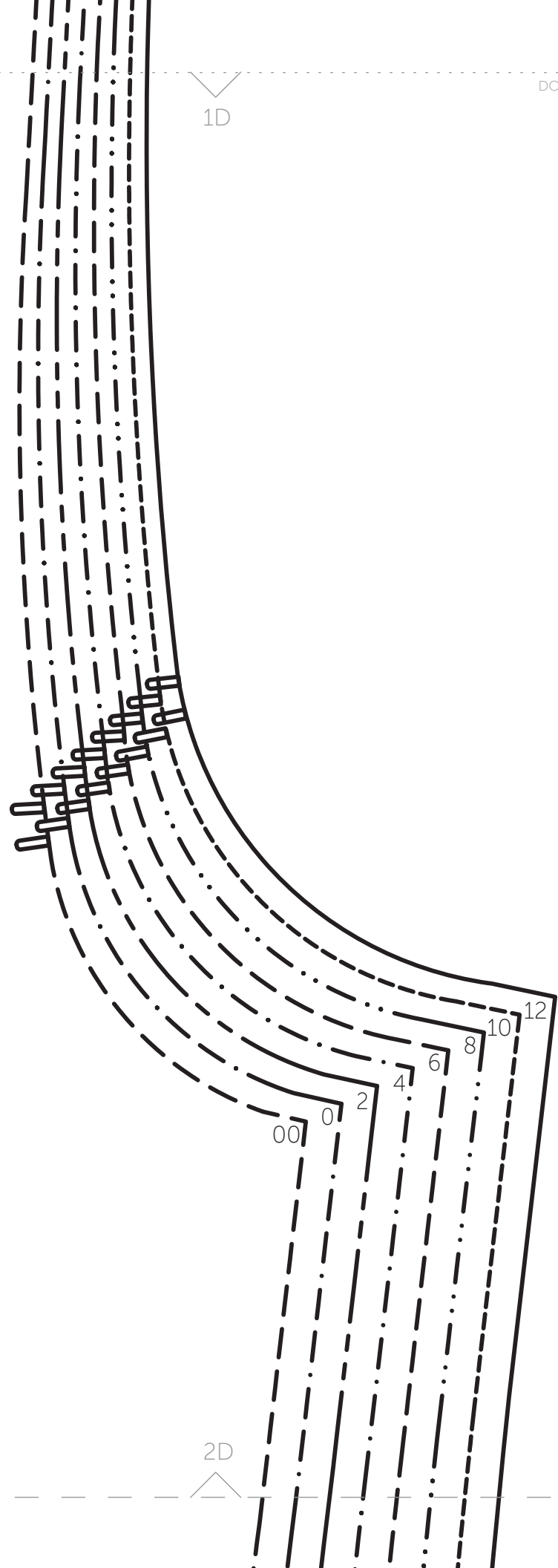



DO NOT CUT

2A



3H



3A



POCKET PLACEMENT

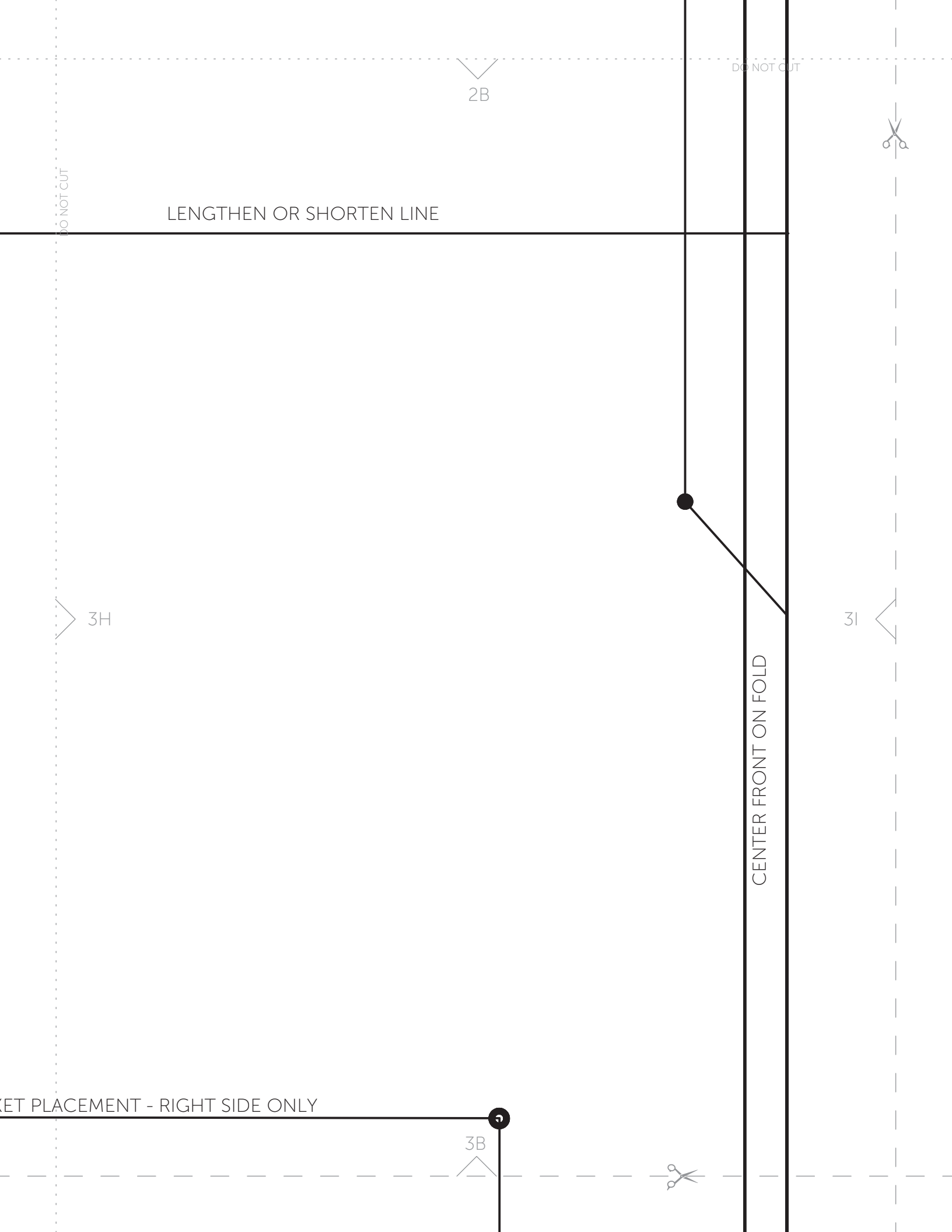

DO NOT CUT

LENGTHEN OR SHORTEN LINE

DO NOT CUT

2B



3H

CENTER FRONT ON FOLD

3I



CKET PLACEMENT - RIGHT SIDE ONLY

3B



DO NOT CUT

2C



LENGTHEN OR SHORTEN LINE

DO NOT CUT

3I

GRAIN LINE

3J



3C

DO NOT CUT

2D

DO NOT CUT



3J

3K

3D

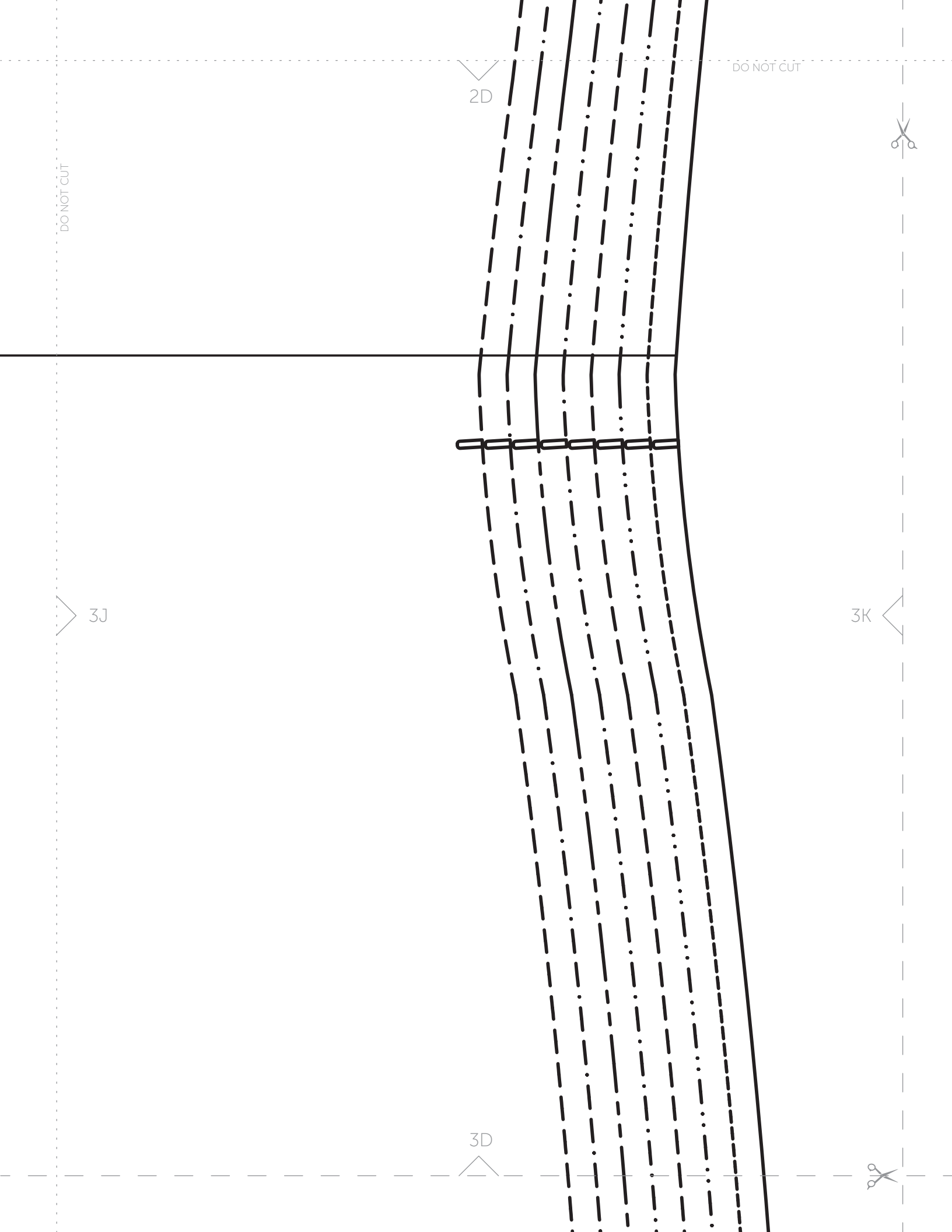

DO NOT CUT

3A



4H



4A



DO NOT CUT

DO NOT CUT

3B

4H

4I

LENGTHEN OR SHORTEN LINE

HEM FOLD LINE - SZ 00

2" (5.1cm) HEM ALLOWED

4B



DO NOT CUT

DO NOT CUT

3C

ZIPPER NOTCH



4I

4J



LENGTHEN OR SHORTEN L



4C



DO NOT CUT

DO NOT CUT

3D



4J

4K

SHORTEN LINE

4D





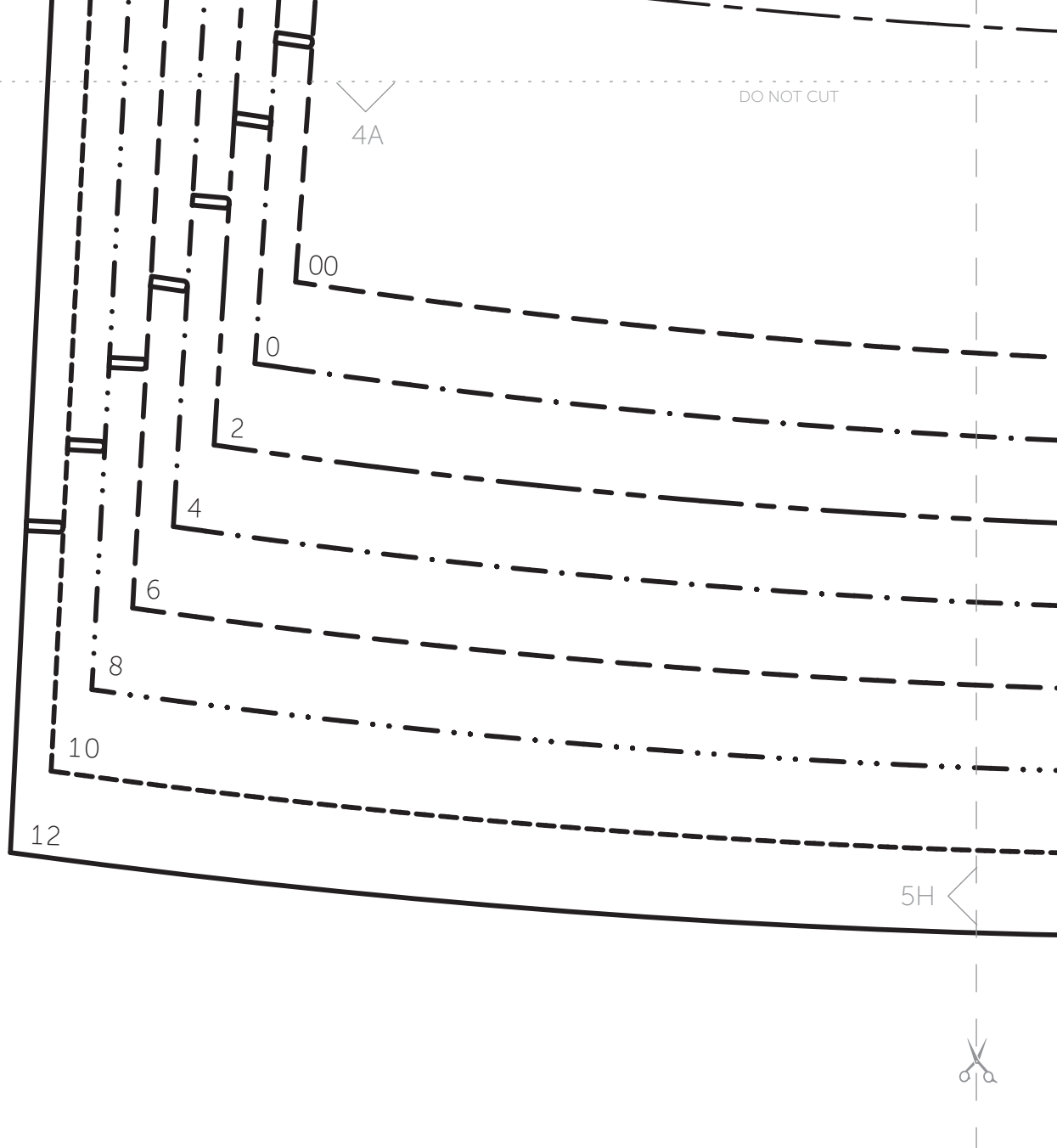

THE  
WOVEN WOLF



FOLD LINE



TUNDRA DRESS

Copyright 2016

CUFF

CUT 2 CONTRAS

CUT 2 FUSIBLE IN

1/2" (1.3 cm) seams allowed

HEM FOLD LINE - SZ 00

2" (5.1cm) HEM ALLOWED



DO NOT CUT



DO NOT CUT



5I

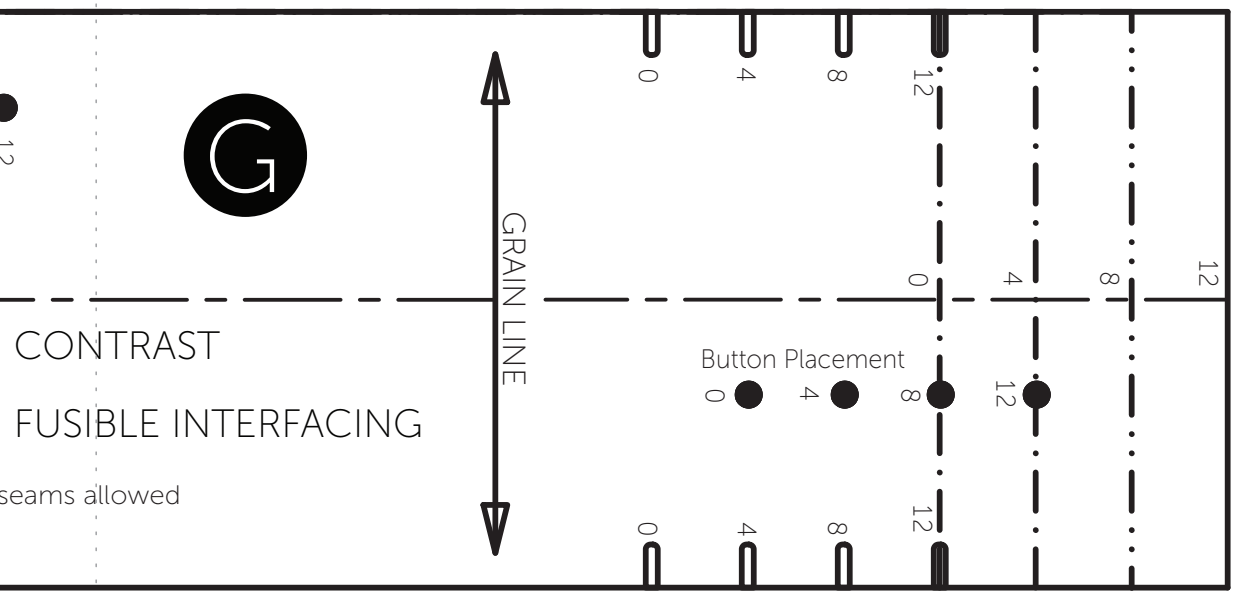

CONTRAST

FUSIBLE INTERFACING

seams allowed

GRAIN LINE

Button Placement

12

8

4

0

0

4

8

12

0

4

8

12

0

4

8

12

12

DO NOT CUT

4C

DO NOT CUT

HEM FOLD LINE - SZ 00

2" (5.1cm) HEM ALLOWED



5I

5J



THE WOVEN WOLF

00 2 6 10 00

FOLD LINE



TUNDRA DRESS

Copyright 2016

CUFF

CUFF 1/2

DO NOT CUT

4D

DO NOT CUT



00

0

2

4

6

8

10

12

5J

2K

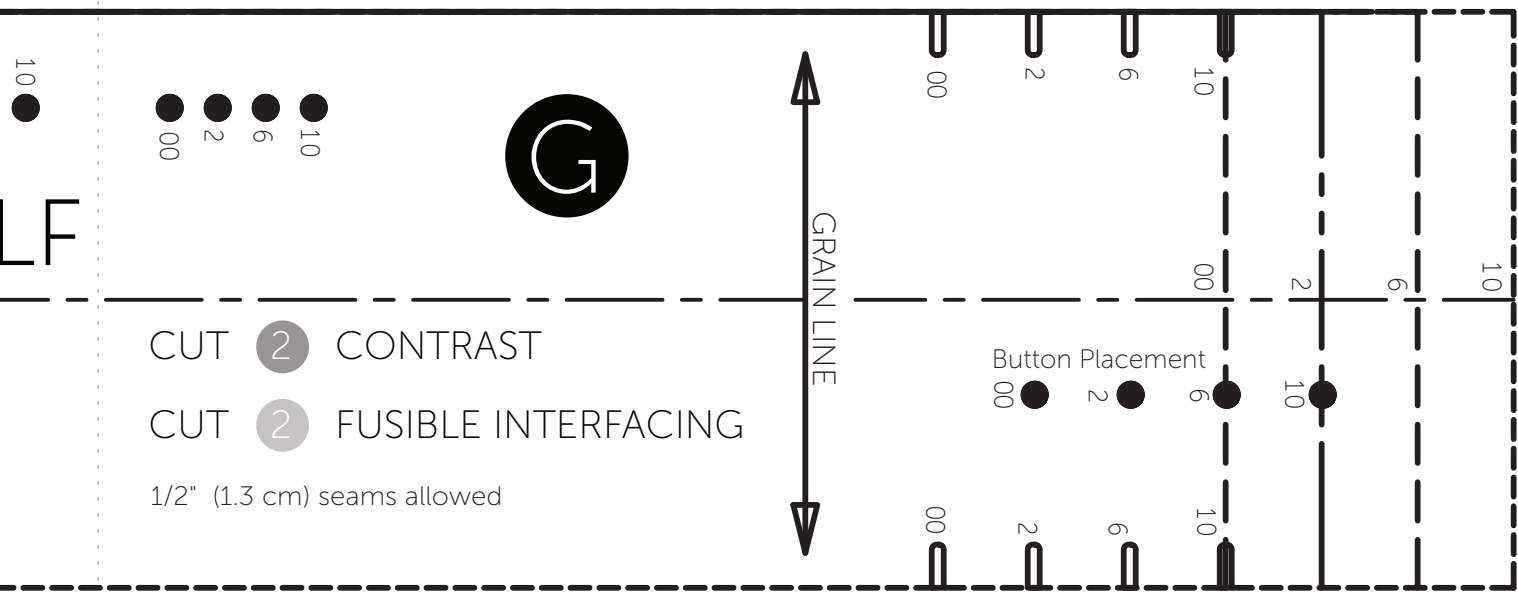

CUT 2 CONTRAST

CUT 2 FUSIBLE INTERFACING

1/2" (1.3 cm) seams allowed

Button Placement

00 ● 2 ● 6 ● 10 ●

DO NOT CUT

1K

1L

1E

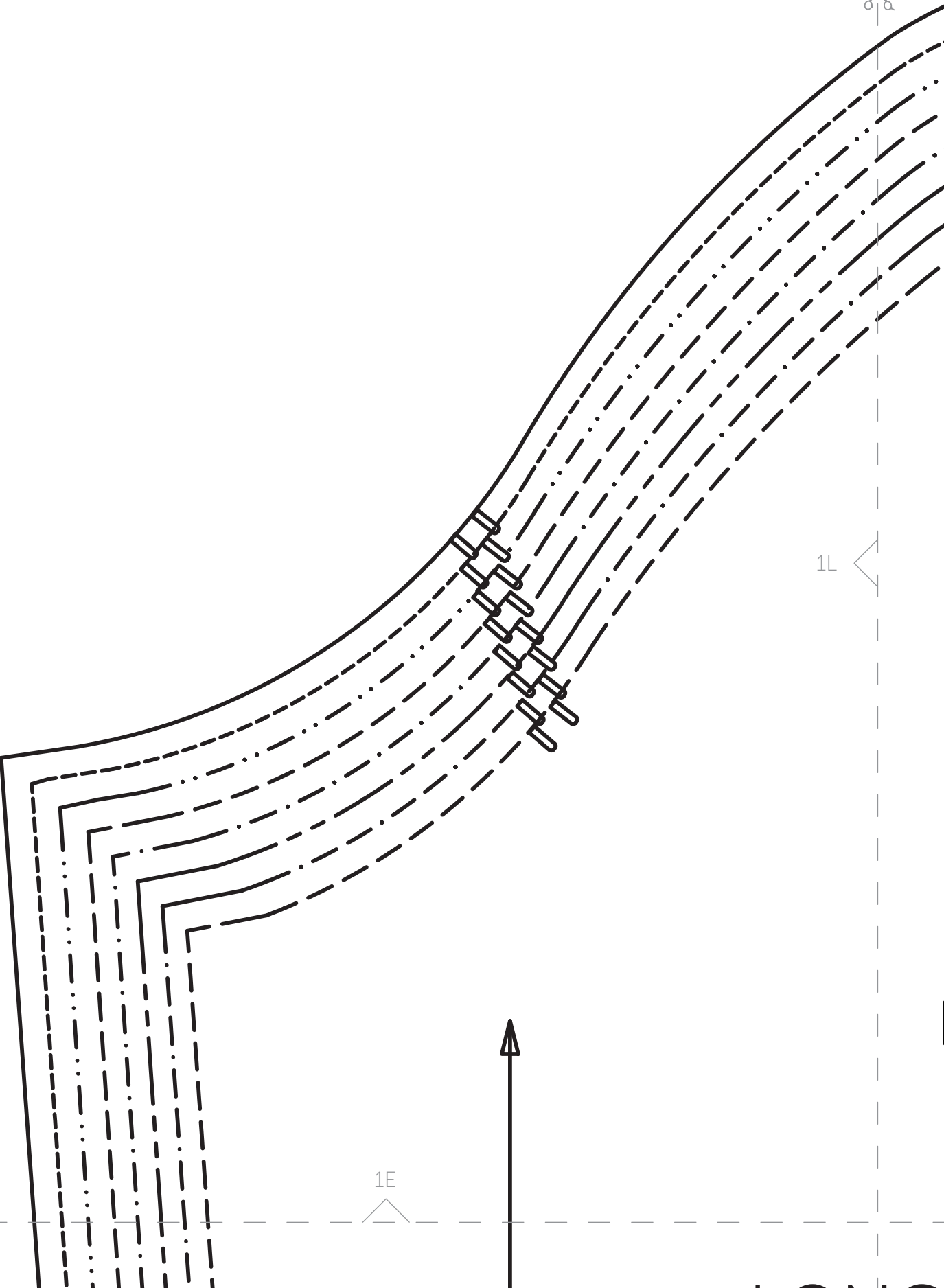

DO NOT CUT

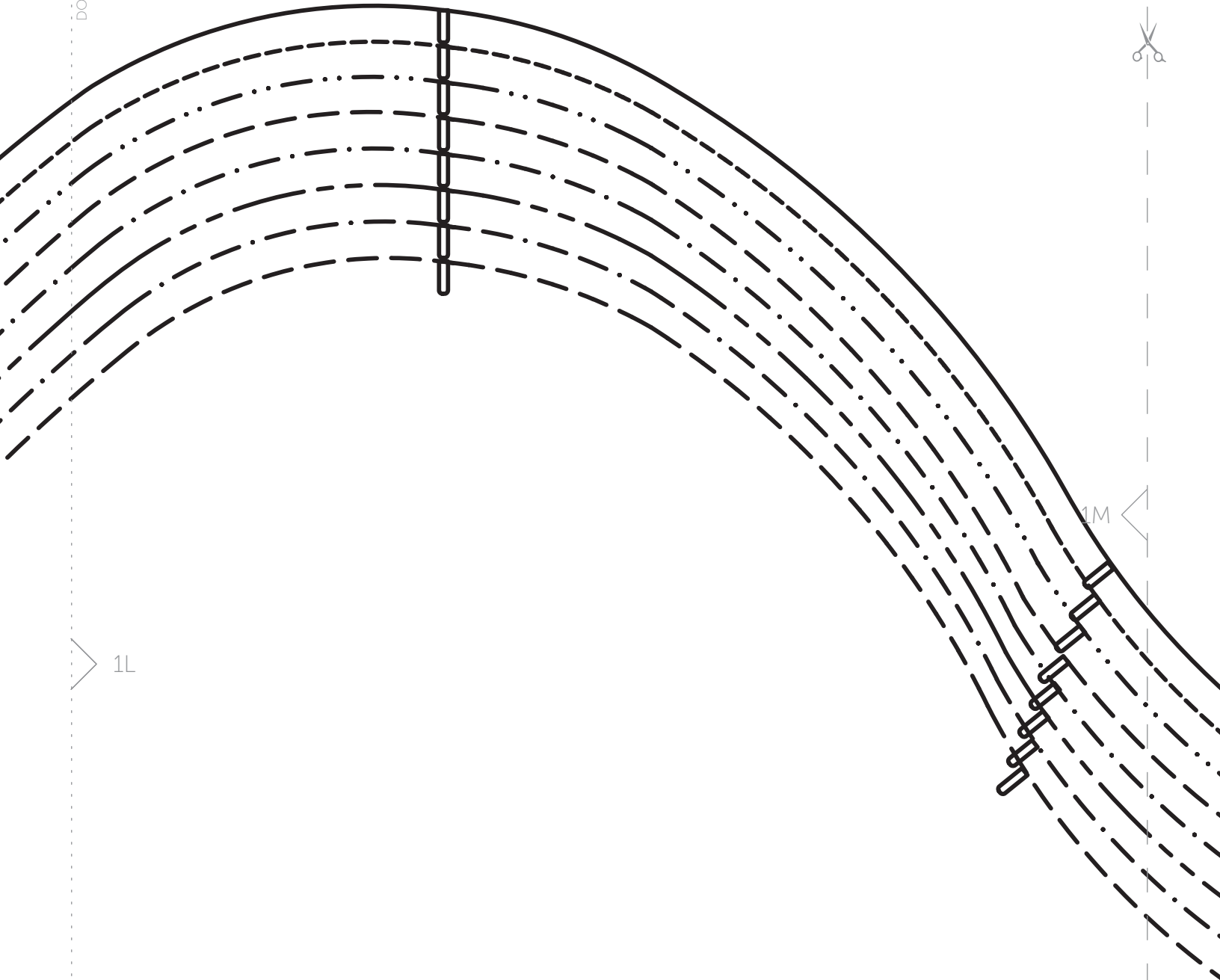

1L

1M

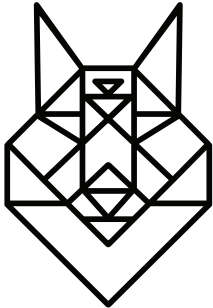

THE  
WOVEN  
WOLF

TUNDRA DRESS 1F



Copyright 2016



DO NOT CUT

1M

1G



LONG

GRAIN LINE



2L

PLEAT



1E



2E



Leave open to notch for Cuff

00  
0  
2  
4  
6  
8  
10  
12

DO NOT CUT

DO NOT CUT

2K





# TUNDRA DRESS

Copyright 2016



DO NOT CUT

## LONG SLEEVE - VERSION 1



CUT **2** SELF FABRIC

1/2" (1.3 cm) seams allowed



DO NOT CUT



DO NOT CUT

1G

2M

Leave open to notch for Cuff

12  
10  
8  
6  
4  
2  
0  
00

2G

DO NOT CUT



DO NOT CUT

DO NOT CUT

2E

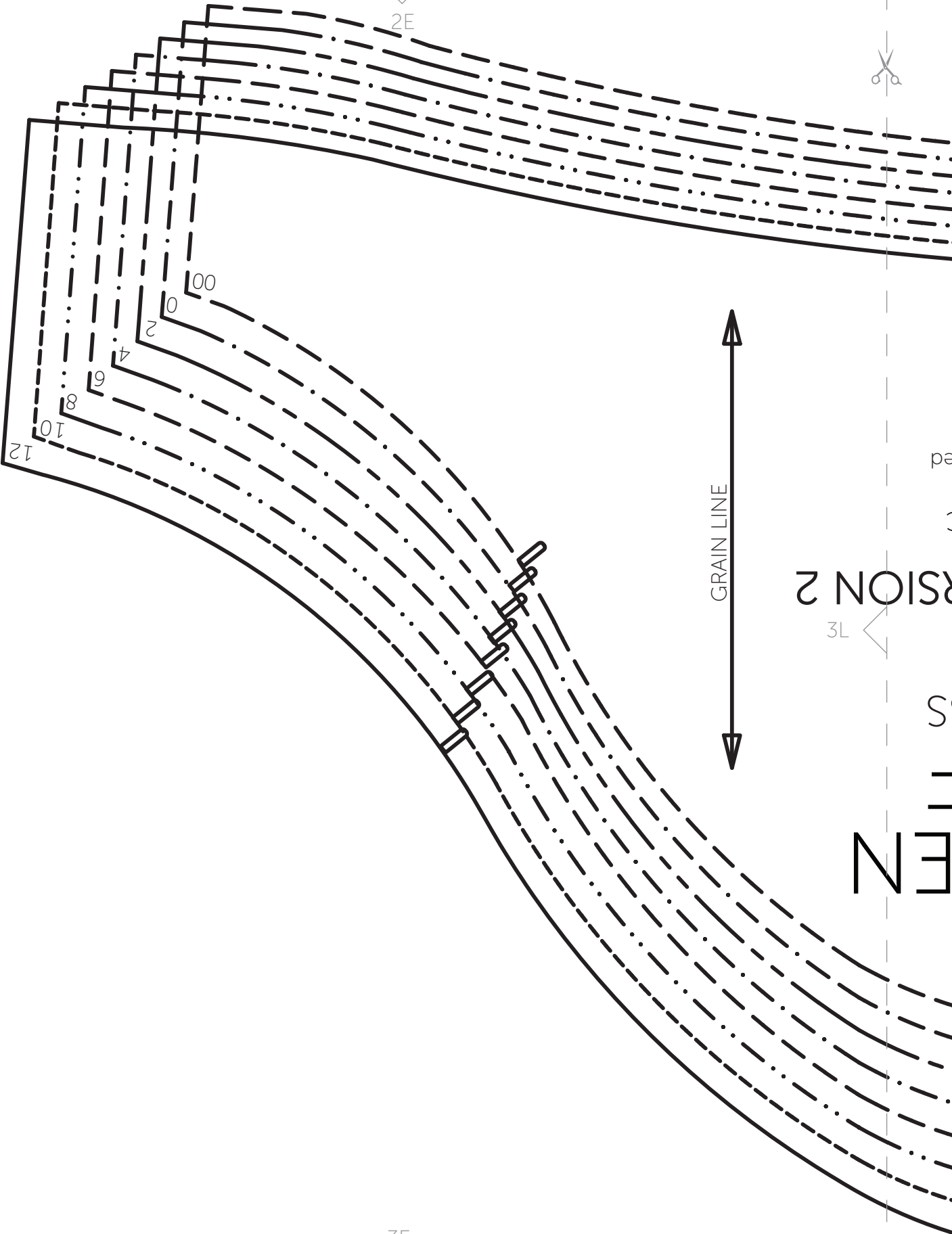

GRAIN LINE

SECTION 2

3L

EN

3K

3E



DO NOT CUT

2F

DO NOT CUT

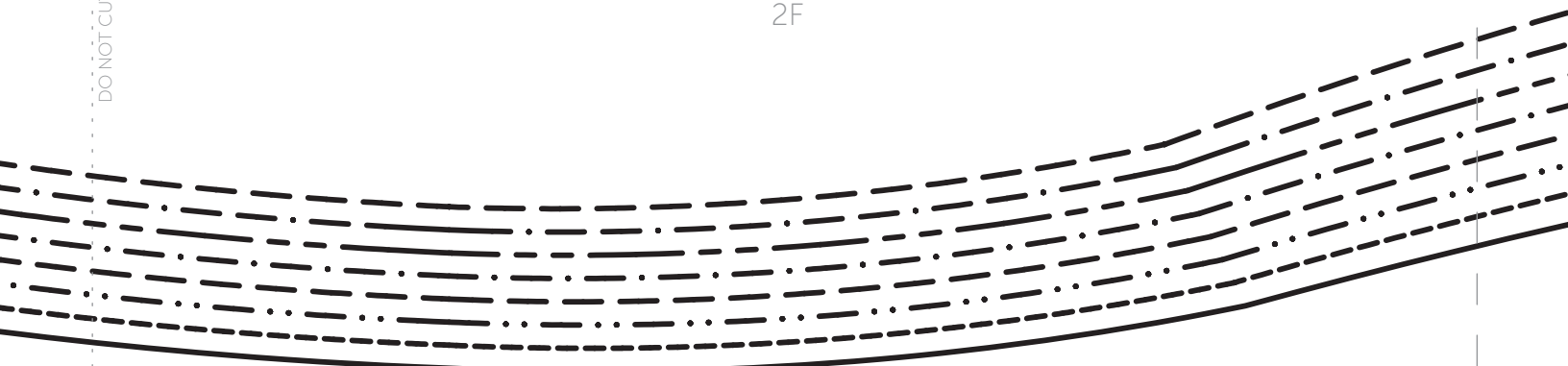

1/2" (1.3 cm) seams allowed

CUT 4 SELF FABRIC

# SHORT SLEEVE - VERSION

13

Copyright 2016

## TUNDRA DRESS

# THE WOVEN WOLF

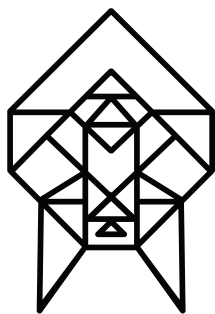

3M

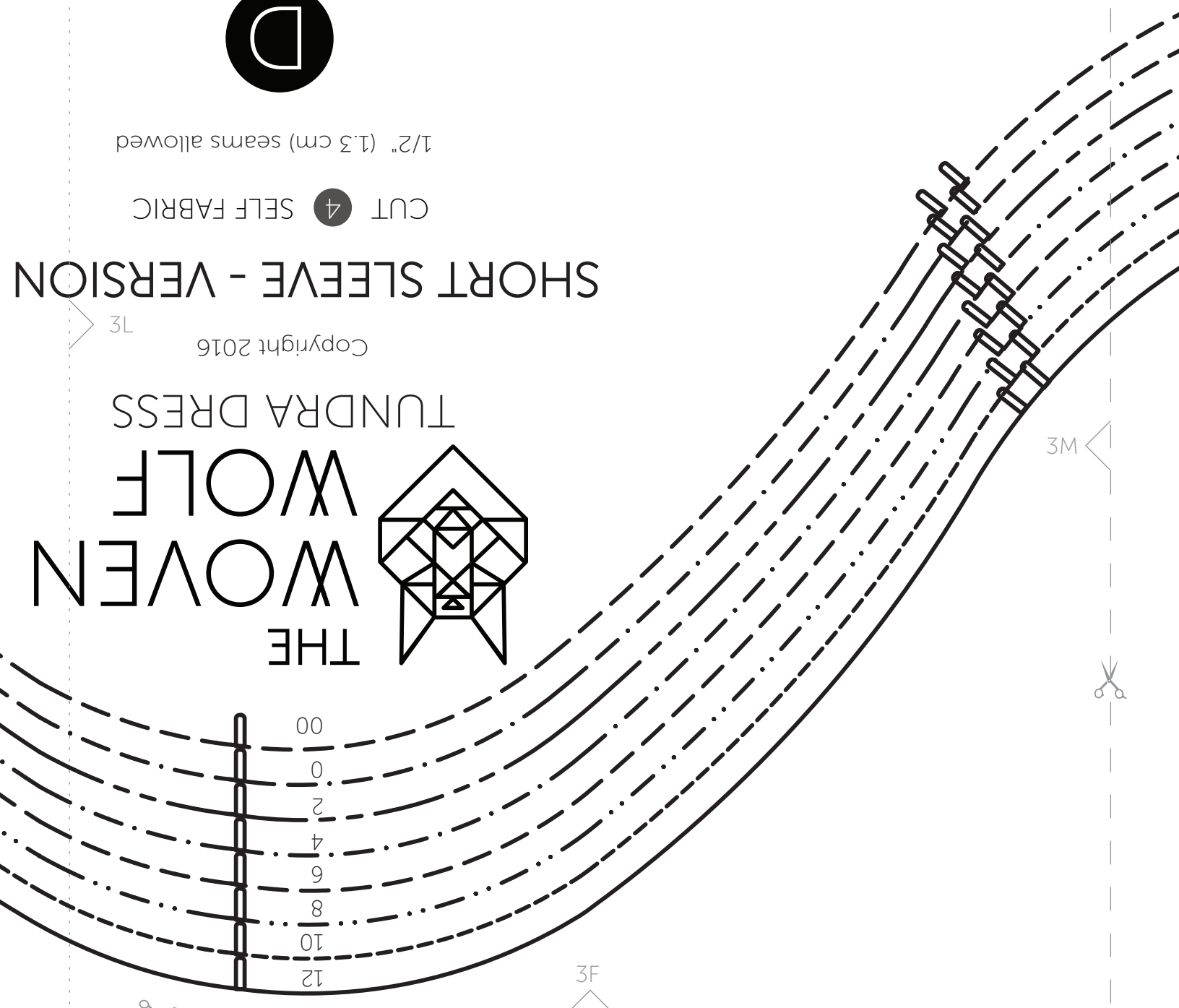

3F



00  
0  
2  
4  
6  
8  
10  
12

DO NOT CUT

2G

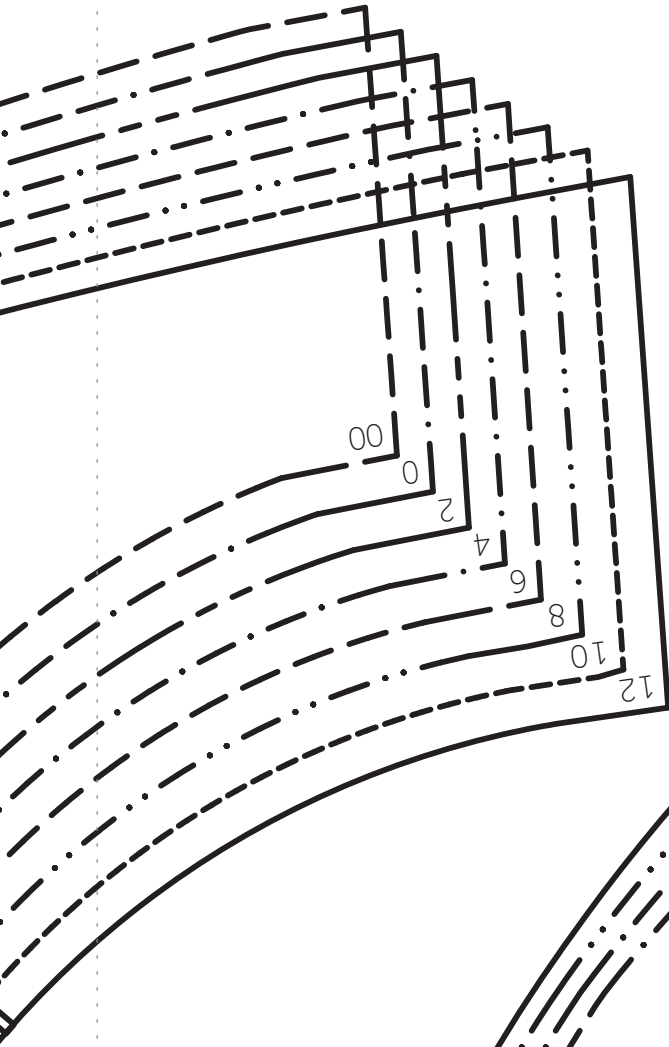

3M



THE  
WOVEN  
WOLF

TUNDRA DRESS

Copyright 2016

NECK FACING

CUT **1** CONTRAST

1/2" (1.3 cm) seams allowed  
unless otherwise indicated

3G

DO NOT CUT



DO NOT CUT

3E

DO NOT CUT



FOLD LINE



4L

4K



# THE WOVEN WOLF

## TUNDRA DRESS

Copyright 2016

## PLACKET



CUT 1 CONTRAST

CUT 1 INTERFACING

1/2" (1.3 cm) seams allowed

GRAIN LINE



4E



DO NOT CUT



3F

FOLD LINE

4M

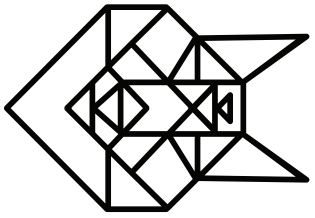

# THE WOVEN WOLF

## TUNDRA DRESS

Copyright 2016

# POCKET

CUT 1 SELF FABRIC

1/2" (1.3 cm) seams allowed



4L

GRAIN LINE



4F



DO NOT CUT

12

1/2" (1.3 cm) seams allowed unless otherwise indicated

DO NOT CUT

3G



CF on fold

DO NOT CUT

FOLD LINE

4M

4G

10

6

2

00

10

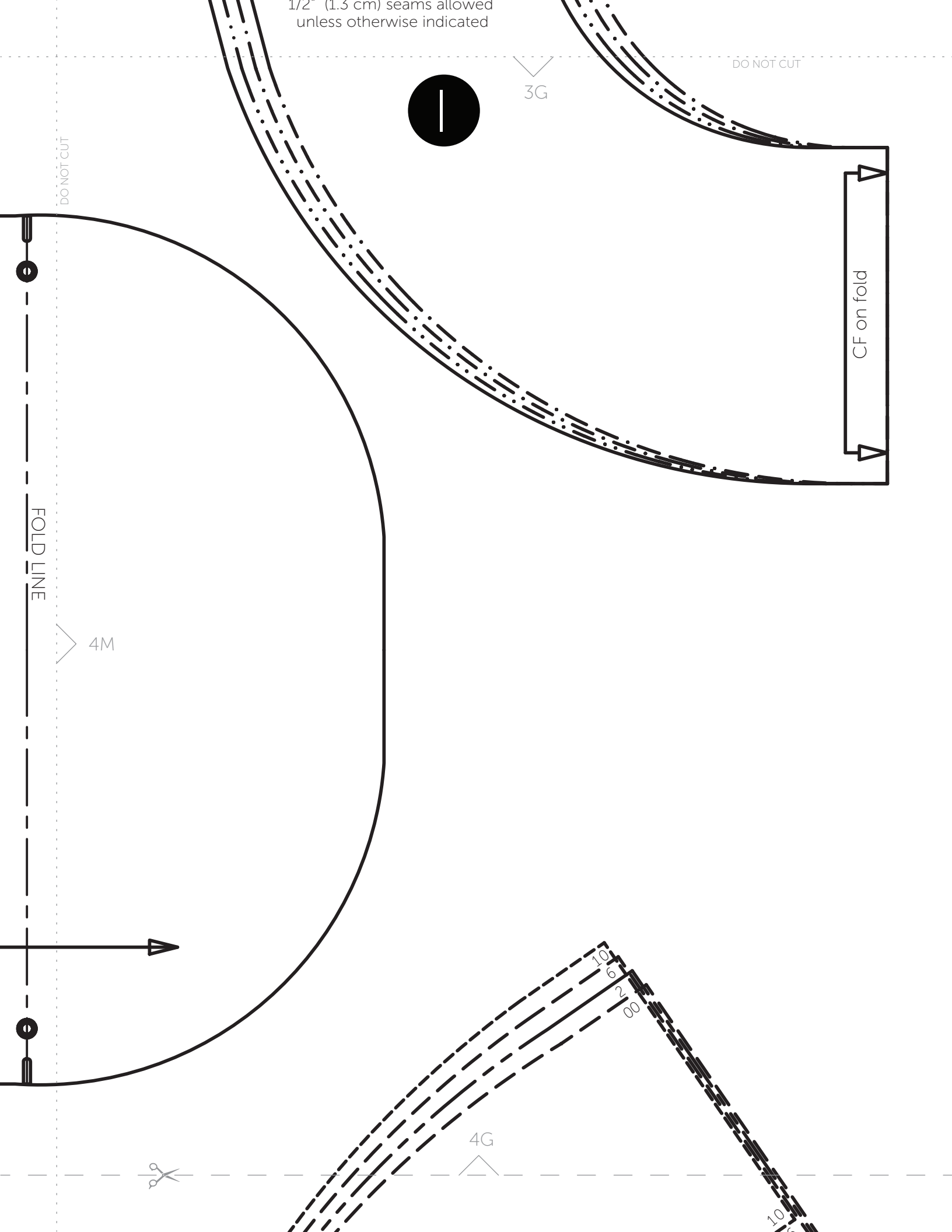



DO NOT CUT

DO NOT CUT

4E



5K

5L

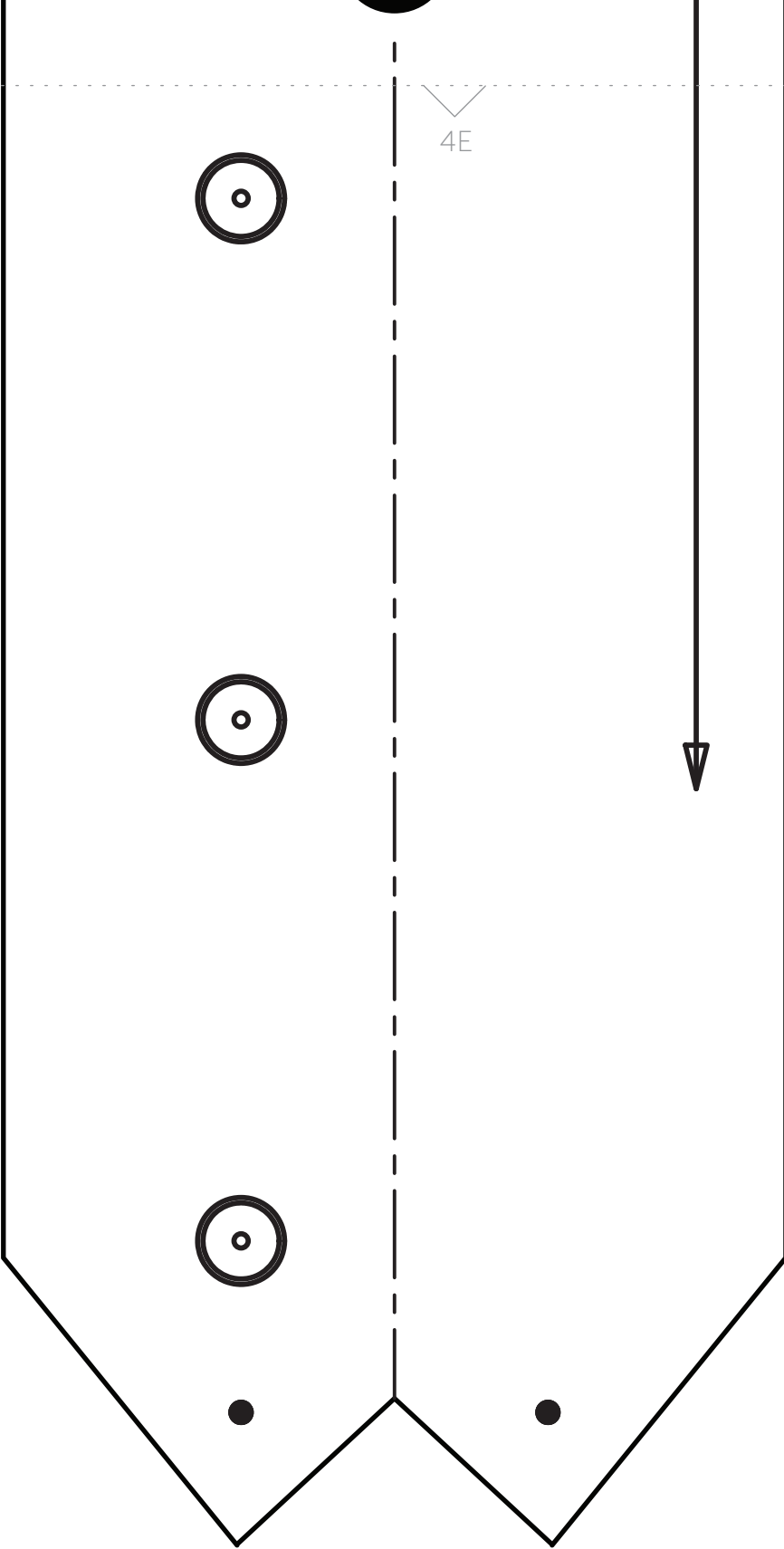

DO NOT CUT



4F

DO NOT CUT

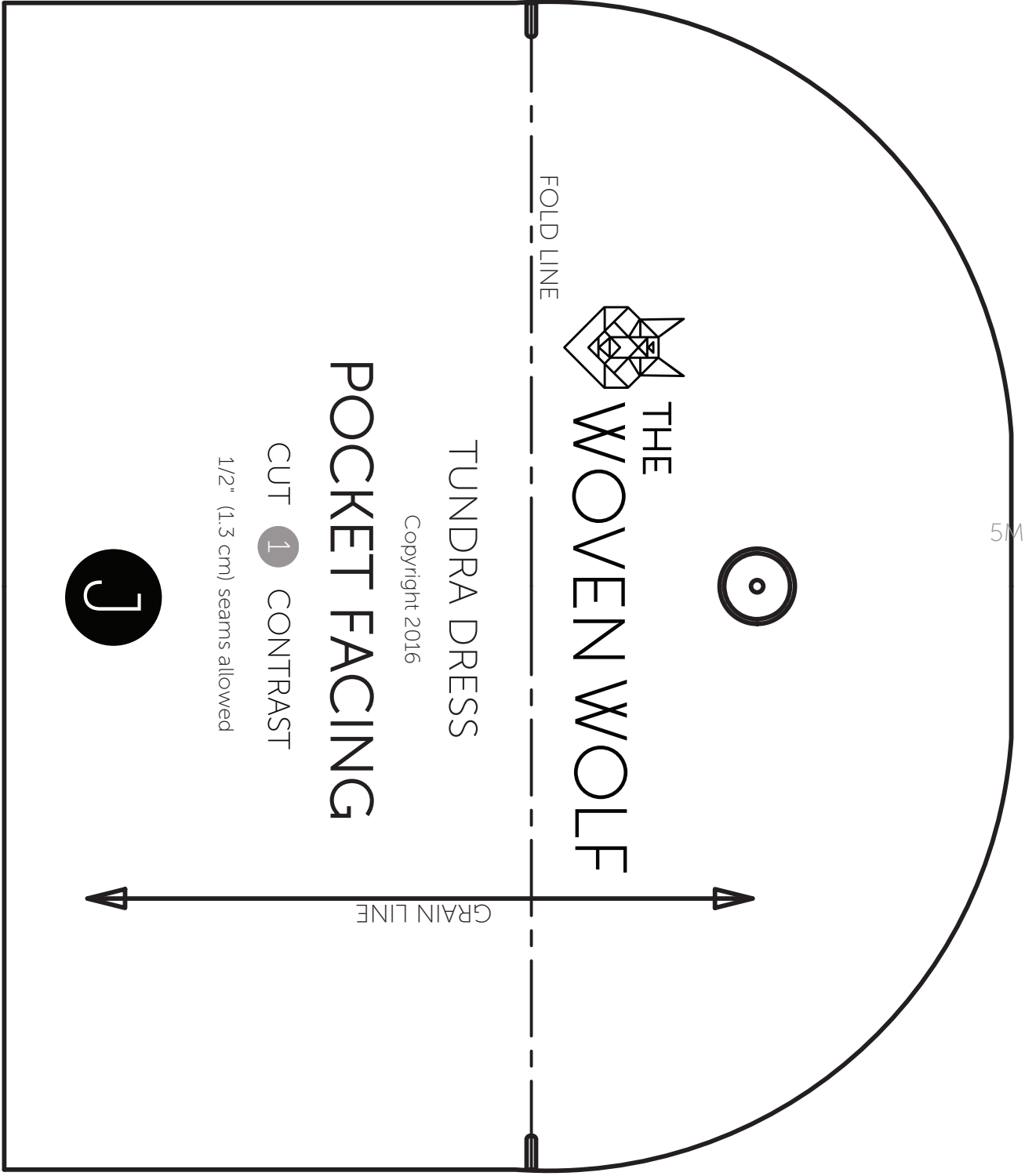

5M



5L

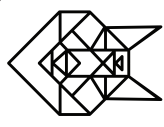

THE  
WOVEN WOLF

TUNDRA DRESS

Copyright 2016

POCKET FACING

CUT **1** CONTRAST

1/2" (1.3 cm) seams allowed



GRAIN LINE



DO NOT CUT

4G

10  
6  
2  
00

DO NOT CUT



THE  
WOVEN  
WOLF

TUNDRA DRESS

Copyright 2016

NECK FACING

CUT 1 CONTRAST

1/2" (1.3 cm) seams allowed  
unless otherwise indicated



5M

CF on fold